

Features

- LO 2 TO 18 GHz
- RF 2 TO 18 GHz
- IF 0.03 TO 4 GHz
- LO DRIVE: +10 dBm (NOMINAL)
- WIDE BANDWIDTH

Description

M93 is a triple balanced mixer, designed for use in military, commercial and test equipment applications. The design utilizes Schottky ring quad diodes and broadband soft dielectric baluns to attain excellent performance. The use of high temperature solder assembly processes used internally makes it ideal for use in manual, semi-automated assembly. Environmental screening available to MIL-STD-883, MIL-STD-202 or MIL-DTL-28837, consult factory.

Product Image

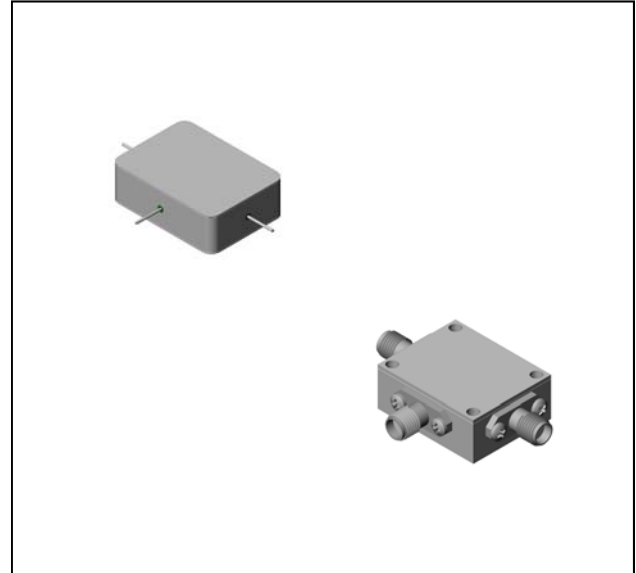

Ordering Information

Part Number	Package
M93	Minpac
M93C	SMA Connectorized

Electrical Specifications: $Z_0 = 50\Omega$ $Lo = +10$ dBm (Downconverter Application only)

Parameter	Test Conditions	Units	Typical	Guaranteed	
				+25°C	-54° to +85°C
SSB Conversion Loss (max) & SSB Noise Figure (max)	fR = 2 to 10 GHz, fL = 2 to 14 GHz, fI = 0.03 to 4 GHz fR = 10 to 18 GHz, fL = 6 to 18 GHz, fI = 0.03 to 4 GHz	dB dB	7.5	10.0	10.5
			8.0	11.0	11.5
Isolation, L to R (min)	fL = 2 to 18 GHz	dB	29	15	13
Isolation, L to I (min)	fL = 2 to 18 GHz	dB	34	16	14
1 dB Conversion Comp.	fL = +10 dBm	dBm	+4		
Input IP3	fR1 = 6 GHz at -6 dBm, fR2 = 6.01 GHz at -6 dBm, fL = 8 GHz at +10 dBm fR1 = 15 GHz at -6 dBm, fR2 = 15.01 GHz at -6 dBm, fL = 18 GHz at +10 dBm	dBm dBm	+14		
			+18		

Typical Performance Curves

Conversion Loss vs. Frequency, LO Power @ +10 dBm

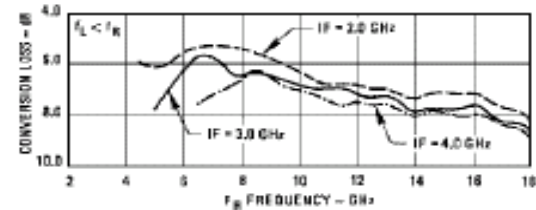
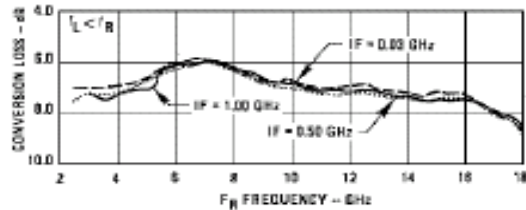
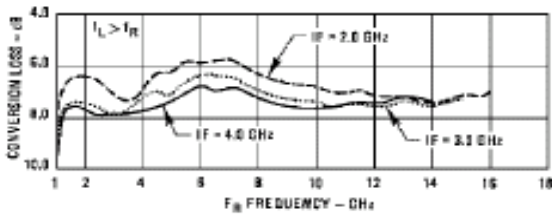
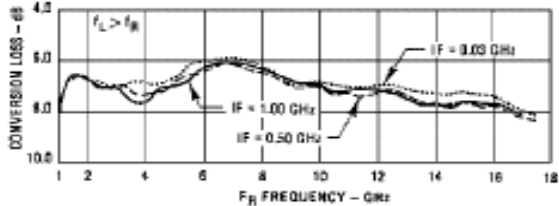

Isolation vs. Frequency, LO Power @ +10 dBm

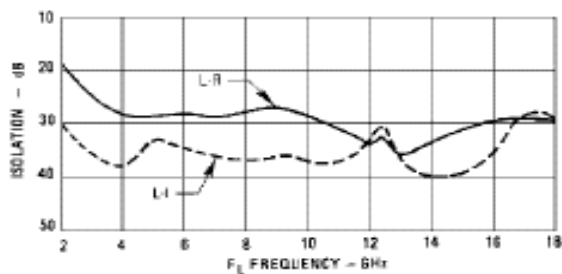

R-Port VSWR vs. Frequency, LO Power @ +10 dBm

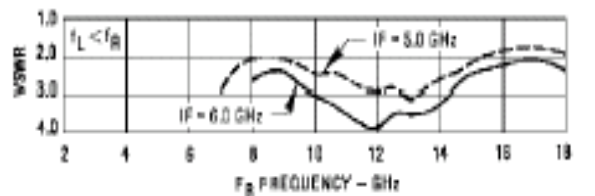
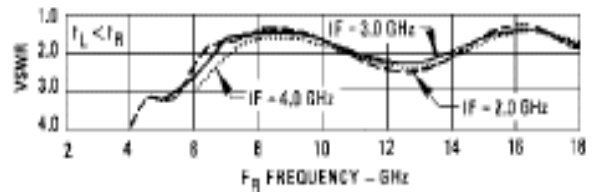
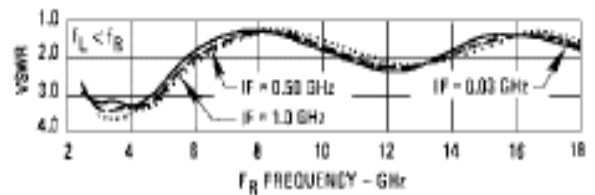
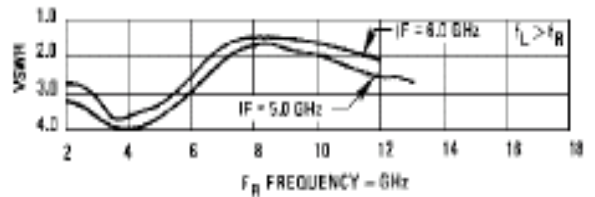
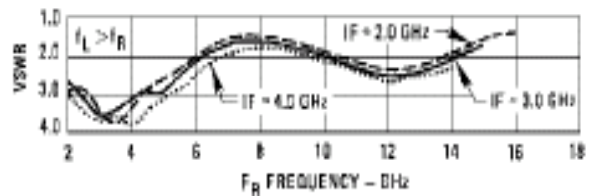
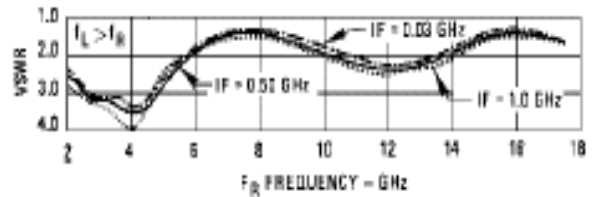

Absolute Maximum Ratings

Parameter	Absolute Maximum
Operating Temperature	-54°C to +100°C
Storage Temperature	-65°C to +100°C
Peak Input Power	+26 dBm max @ +25°C +23 dBm max @ +100°C
Peak Input Current	mA DC

Outline Drawing: Minpac *

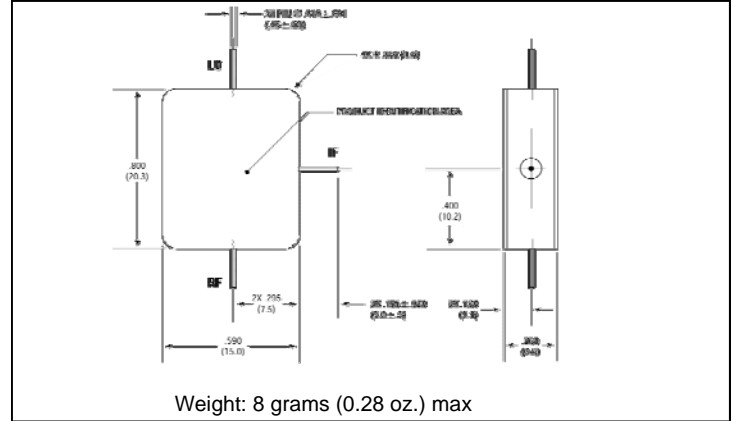

Outline Drawing: SMA Connectorized *

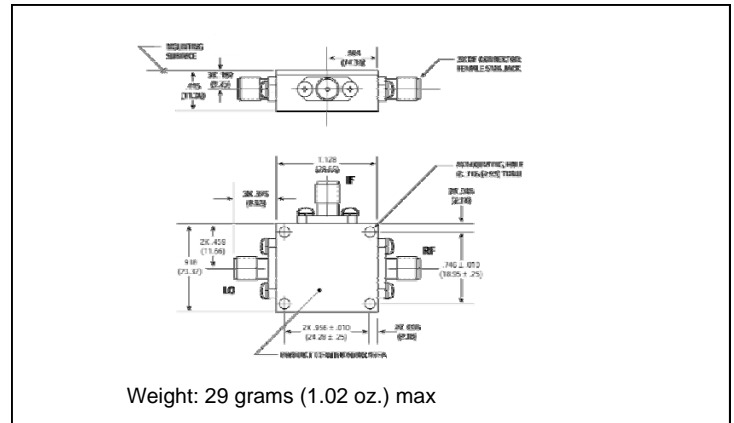

I-Port VSWR vs. Frequency, LO Power @ +10 dBm

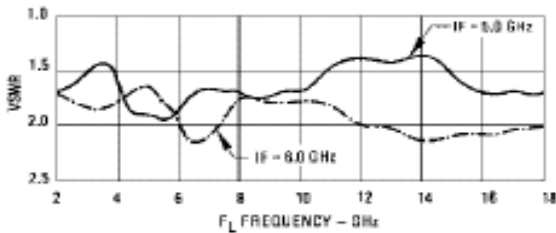
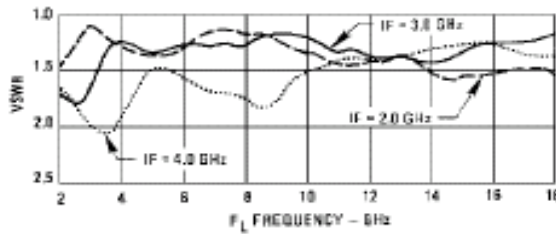
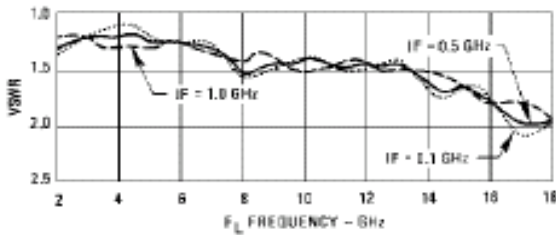

L-Port VSWR vs. Frequency

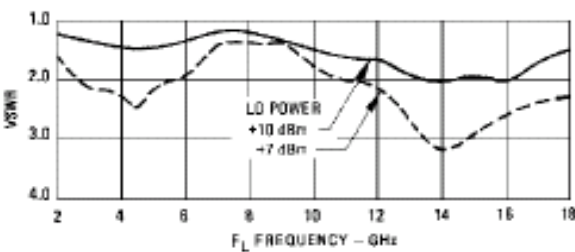

* Dimensions are inches (millimeters) ±0.015 (0.38) unless otherwise specified.